



# Longspan Shelving



**maxrac** 美库®

[www.maxrac.com](http://www.maxrac.com)



Company Profile

Shanghai Maxrac Storage Equipment Engineering Co., Ltd. is one of the Chinese leading manufacturers of pallet racking and shelving systems with a long standing reputation for product quality, technical innovation and first class customer service. Maxrac provides various racking systems including shuttle intensive storage system, automation intelligent intergration system, pallet racking, shelving, mezzanine, cantilever and carton live storage for many industries, which is manufacturing, logistics, cold chain, retail, E-commerce ect. Maxrac export at least 1000 containers to more than 60 countries per year. All Maxrac products are designed and manufactured in accordance with standard of European FEM, Australia AS4084:2012 and American RMI.

Foreign Certificate



ISO9001:2008



AS4084: 2012



CE for pallet rack



RMI



CE for radio shuttle



WMS

Domestic Certificate



China Green Warehousing And Distribution



High technology expertise

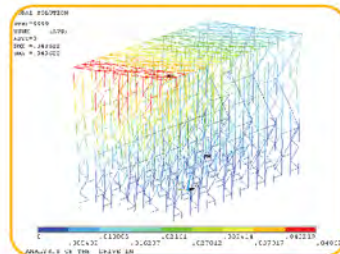

Shanghai Manufacturing Base



R&D Center





# Longspan Shelving

Maxrac® Longspan Shelving is the perfect solution no matter what you need to store from small components to heavy cartons. Maxrac® Longspan Shelving is fast and easy to assemble, and uses a modular design with bolted frames & knock down beams which require no special tools, giving you maximum storage in minutes whatever your available space is.

Maxrac® Longspan Shelving offers you virtually unlimited opportunities to expand your storage capacity, giving you higher density storage and greater flexibility no matter what you are storing. Long, uninterrupted spans of up to 3000mm also make Maxrac® Longspan ideal for a wide range of big and bulky items. Shelves are easily adjusted to your needs as stock patterns change. All components comply with Australian, European and American guidelines for safe storage.



## Upright

Front view

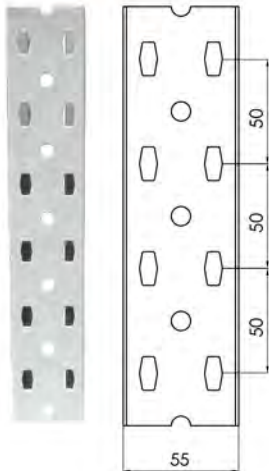

Side view

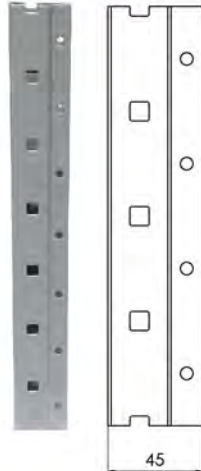

55A Upright

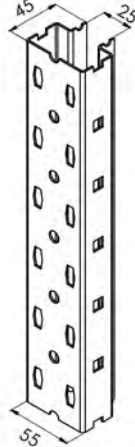

55B Upright

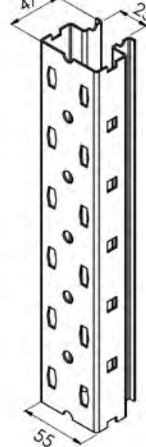

Top view

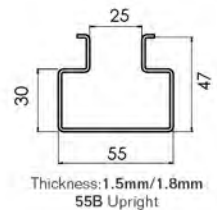
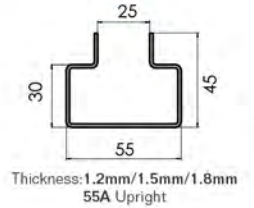

Finish: Powder Epoxy-Polyester Coating, Polymerized at 180 °C, Lead free.

### Standard Colours:

Sky Blue



RAL 5015

Blaze Blue



RAL 5108

Anthracite Grey



RAL 7016

Light Grey



RAL 7035

Traffic Grey



RAL 7042

**Frame & Bracing**



2 Uprights Frame

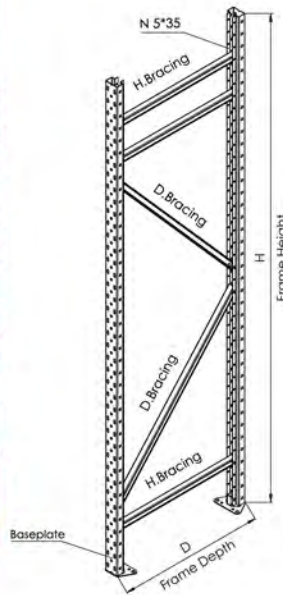

3 Uprights Frame

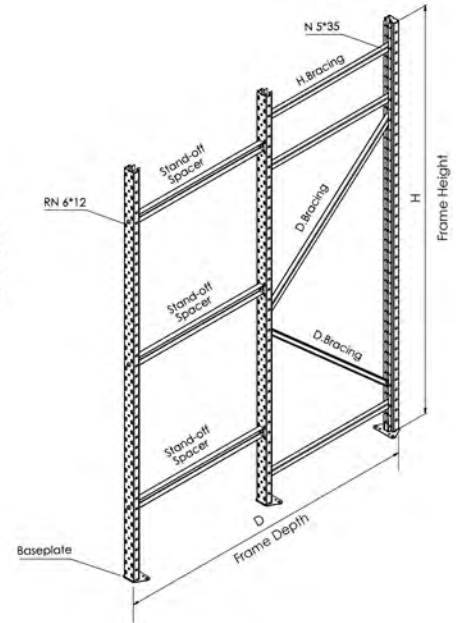

**Beam & Safety Pin**

Maxrac® Longspan Shelving system incorporates a wide range of beams, making it easy to customize to meet your precise needs. Open, mesh clad, medium and longspan bays can be combined in the same unit for efficient storage of a wide range of stock items. A number of high performance accessories are also available to extend the versatility of the Maxrac® Longspan Shelving system still further.



N' Style Beam Connector



Safety Pin

**Beam Length**

Beam length is specified as the distance between connector faces, as shown in right draft.

G = 4.0mm = O' Style Beam Connector

G = 2.0mm = N' Style Beam Connector

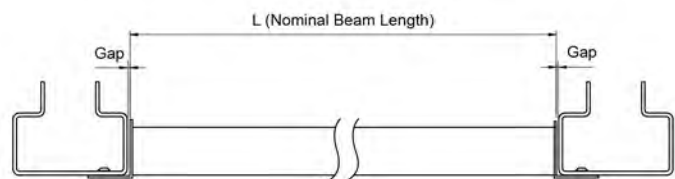



**Step Beam Profiles**

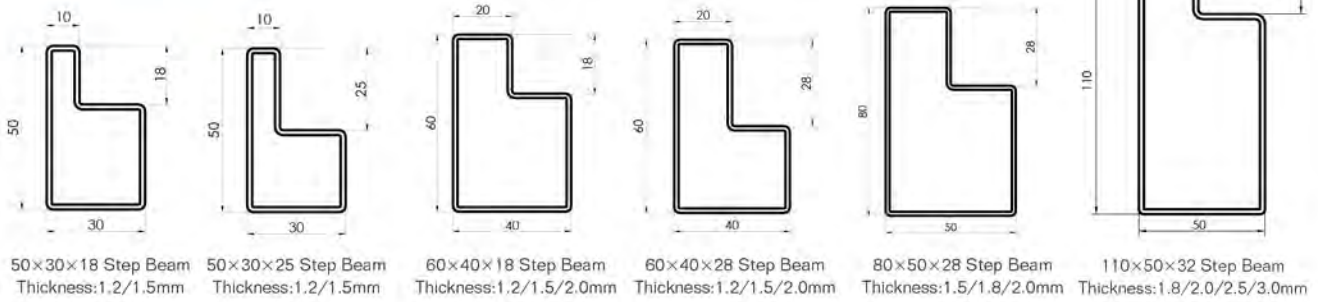

**Rectangle Beam Profiles**

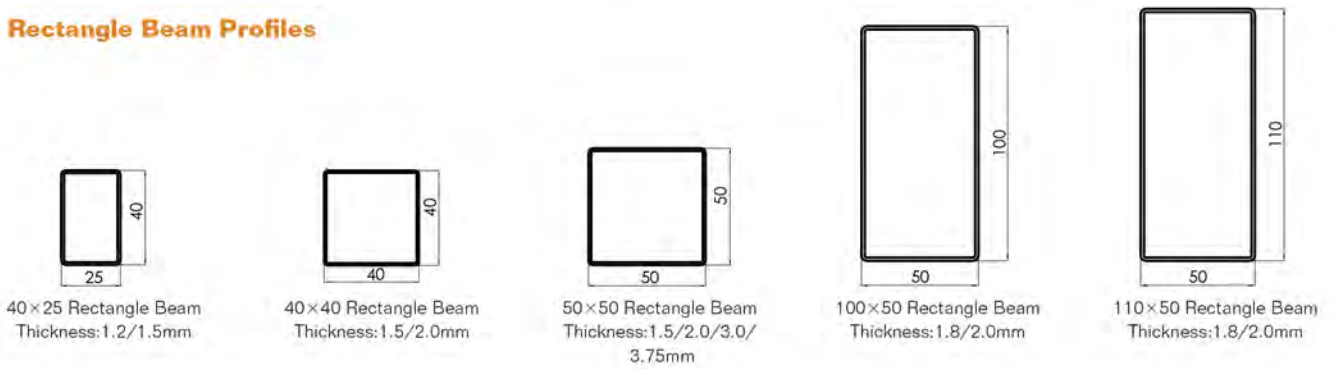

**Other Beam Profiles**

Maxrac® can design and produce special beam profiles for your special requirement, for example round tube beam profiles etc.



Finish: Powder Epoxy-Polyester Coating, Polymerized at 180 0C , Lead free.

**Standard Colours:**



**Baseplate & Shim**





## Shelves

Various Shelves are available for different requirements.



### Chipboard Shelves

- Chipboard is available pre-cut to fit longspan shelving. This is the most cost effective shelves for the system.



### Melamine Faced Shelves

- Provide a wide clean surface where high levels of cleanliness are required such as in pharmaceutical or electronic industries.

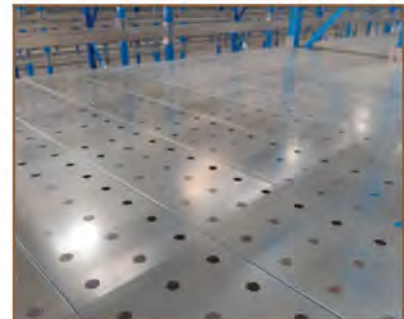

### Steel Shelves

- Pre-Galvanised and Powder Coated steel shelves are available.

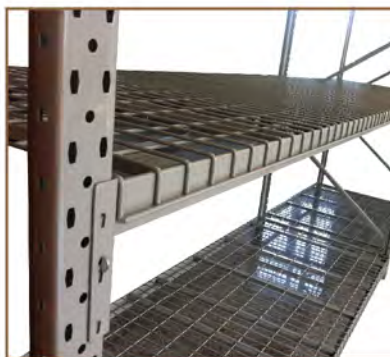

### Wiremesh Shelves

- Wiremesh Shelves are available on all Shelving Systems. Maxrac® offers variety of sizes, capacities, and customized configurations to accommodate any applications.



**Back Panel**



**Side Panel**



**Divider**



**Accessories**



N5 \* 35 Bolt N 5 Nut with Block



RN 6 \* 12 Bolt N 6 Nut with Block



Plastic Upright Endcover



Longspan Upright Splicer

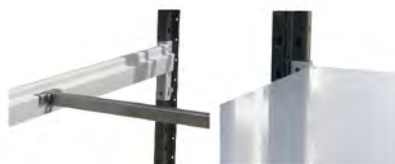

Welded Shelf Support



Knock Down Shelf Support



**Longspan Shelving Application**



Maxrac® Longspan Shelving is the perfect solution no matter what you need to store.

Maxrac® Longspan Shelving system incorporates with a wide range of beams and frames making it easy to customize to meet your precise needs, from small components to heavy cartons.

A number of high-performance accessories are also available to extend the versatility of the Longspan system.





 **Build In Longspan Shelving**

- Quick and easy installation with no special tools and no special training saves your time and money.
- Shelves are easily adjusted to your needs as stock patterns change.
- Safety-all designed components comply with Australian, European and American guidelines for safe storage.







*Speed up your logistics*

**SHANGHAI MAXRAC STORAGE EQUIPMENT ENGINEERING CO.,LTD**

ADD: 1204, Yong Ye Mansion, No. 2240 South Pudong Road,  
Pudong New District, Shanghai, P.R. China 200127

Tel: +86-21-51876818 Fax: +86-21-51876819

E-mail: [sales@maxrac.com](mailto:sales@maxrac.com)

[www.maxrac.com](http://www.maxrac.com)